

## INDEX

MODEL	SALES DESIGNATION
107.045.....	380 SL

CIRCUIT	PAGE	CIRCUIT	PAGE
Air Injection Management .....	109	Lights (continued)	
Anti Lock Brake System .....	132	—Glove Box .....	111
Automatic Antenna .....	127	—Hazard .....	116
Automatic Climate Control .....	141	—Headlights .....	112
Auxiliary Fan .....	123	—Instrument Cluster .....	122
Charging System .....	110	—License .....	115
Cigar Lighter .....	127	—Marker .....	115
Clock .....	120	—Park .....	114
Cold Start .....	106	—Stop .....	112/2
Component Locations .....	201	—Tail .....	114
Cruise Control .....	112/2	—Trunk .....	115
Diagnostic Socket .....	107, 108	—Turn Signal .....	116
Fuel Delivery .....	107	—Vanity .....	121/1
Fuse Box .....	103	Outside Heated Mirrors .....	130
Fuse-Circuit List .....	102	Power Distribution .....	104
Gauges .....	118	Power Distribution—ACC .....	141
Ground Distribution .....	138	Power Windows .....	126
Ground Distribution — ACC .....	141	Radio .....	127
Heated Seats .....	128	Rear Defogger .....	125
Horns .....	123	RH Outside Mirror .....	129
Idle Speed Stabilization .....	109	Start .....	106
Ignition .....	107	Supplemental Restraint System .....	131
Lambda Control .....	108	Tachometer .....	118
Lights		Transmission Kickdown .....	107
—Backup .....	111	Warning Indicators .....	118
—Center Console .....	122	Warning System .....	117
—Courtesy .....	121	Wiper/Washer .....	124
—Fog Lights .....	112		

REVISIONS:
------------

## FUSE-CIRCUIT LIST

MY 1983 - MY 1985

380 SL

No.	Fuse		Circuits Protected	Connection to Circuit	Page
	Amps (Color)				
1	8 (WT) ① 16 (PK)	①	Cigar Lighter/Radio	15R	127
			Glove Box Lamp		111
			Heated Seats		128
			RH Outside Mirror		129
2	16 (PK)		Headlamps	15R	112
			Wiper/Washer		124
3	16 (PK)		Power Windows (RH)	15	126
4	16 (PK)		Power Windows (LH)	15	126
5	8 (WT)		Anti-Lock Brake System	15	132
			Power Windows		126
			Stop Lamps/Cruise Control		112/2
			Turn Signal/Hazard Lamps		116
			Warning Indicators		118
			Warning System		117
6	25 (BU)		Automatic Climate Control	15X	141
7	8 (WT)		Air Injection Management	15	109
			Automatic Climate Control		141
			Auxiliary Fan		123
			Backup Lamps		111
			Transmission Kickdown		107
			Warning Indicators		120
8	8 (WT) ②		Horns	15	123
			Outside Heated Mirrors		130
9			Not Used		
10	16 (PK)		Rear Defogger	15	125

No.	Fuse		Circuits Protected	Connection to Circuit	Page
	Amps (Color)				
11	8 (WT)		Not Used		
12	8 (WT)		Automatic Antenna	30	127
			Clock		120
			Courtesy Lamps		121
			Diagnostic Socket		107
			Radio		127
			Trunk Lamp		115
			Turn Signal/Hazard Lamps		116
Warning System	117				
13	8 (WT)		Illumination: Instrument	58R	122
			Cluster/Center Console		115
			Lamps: Marker/License		114
			Lamps: Park/Tail (RH)		117
14	16 (PK)		Auxiliary Fan	30	123
15	8 (WT)		Not Used		
16	8 (WT)		Lamps: Park/Tail (LH)	58L	114
17	8 (WT)		Headlamps (RH High Beam & Indicator)	56a	112
18	8 (WT)		Headlamps (LH High Beams)	56a	112
19	16 (PK)		Headlamps (RH Low Beam)/ Fog Lamps	56b	112
20	8 (WT)		Headlamps (LH Low Beam)	56b	112

## REVISIONS:

- ① WITH HEATED SEATS  
② 16 AMP (AS OF MODEL YEAR 1985)

# WARNING INDICATORS/GAUGES/CLOCK

(For Component Locations See Page 212)

MY 1983/MY 1984/  
MY 1985  
380 SL

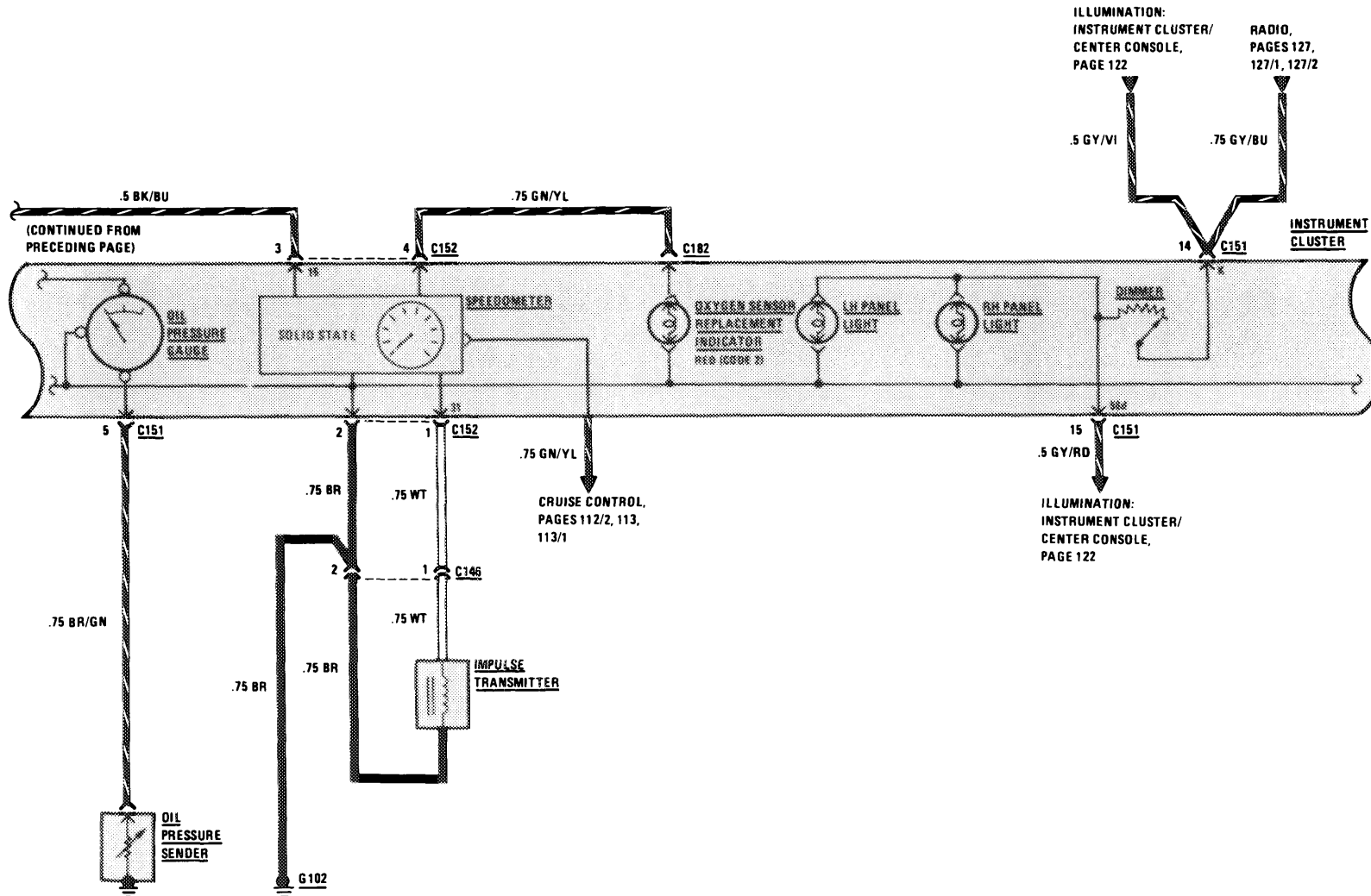

107.045

119

REVISIONS:

--	--	--

# WARNING INDICATORS/GAUGES/CLOCK

(For Component Locations See Page 212)

MY 1983/MY 1984/  
MY 1985 380 SL

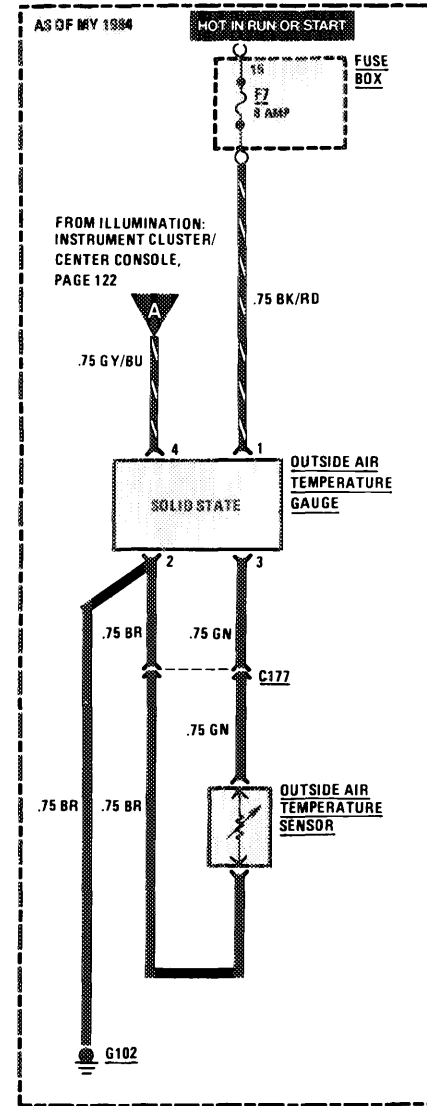
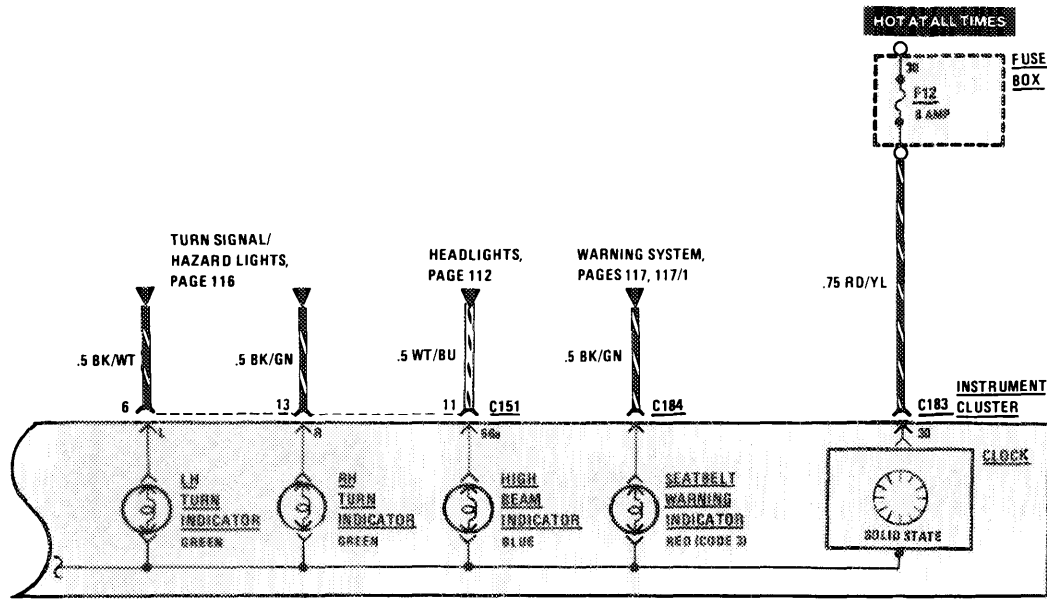

REVISIONS:

# COURTESY LIGHTS

(For Component Locations See Page 204)

MY 1983/MY 1984

380 SL

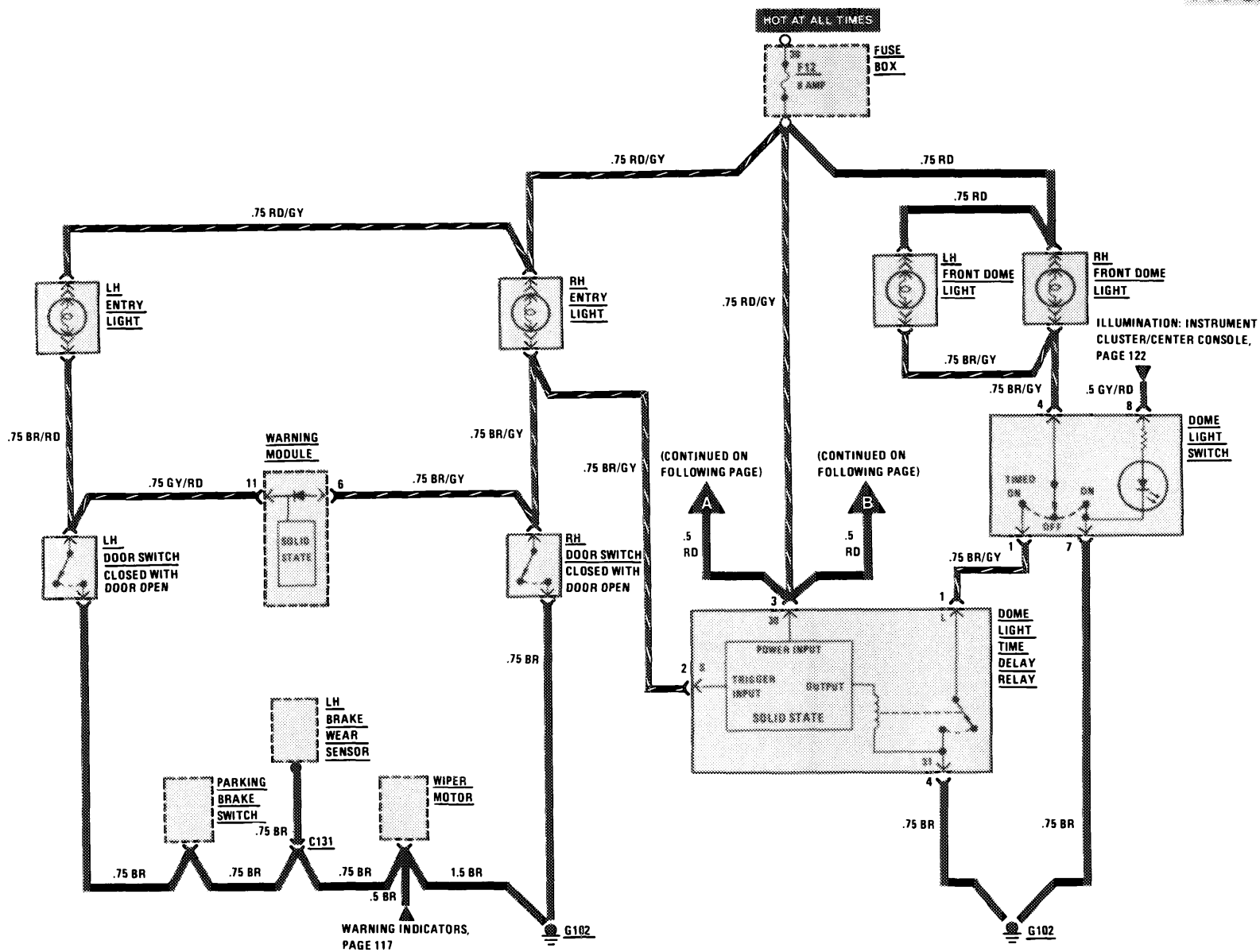

4/86

107.045

121

REVISIONS:

# VANITY LIGHTS

(For Component Locations See Page 204)

MY 1983/MY 1984

380 SL

(CONTINUED FROM PRECEDING PAGE)

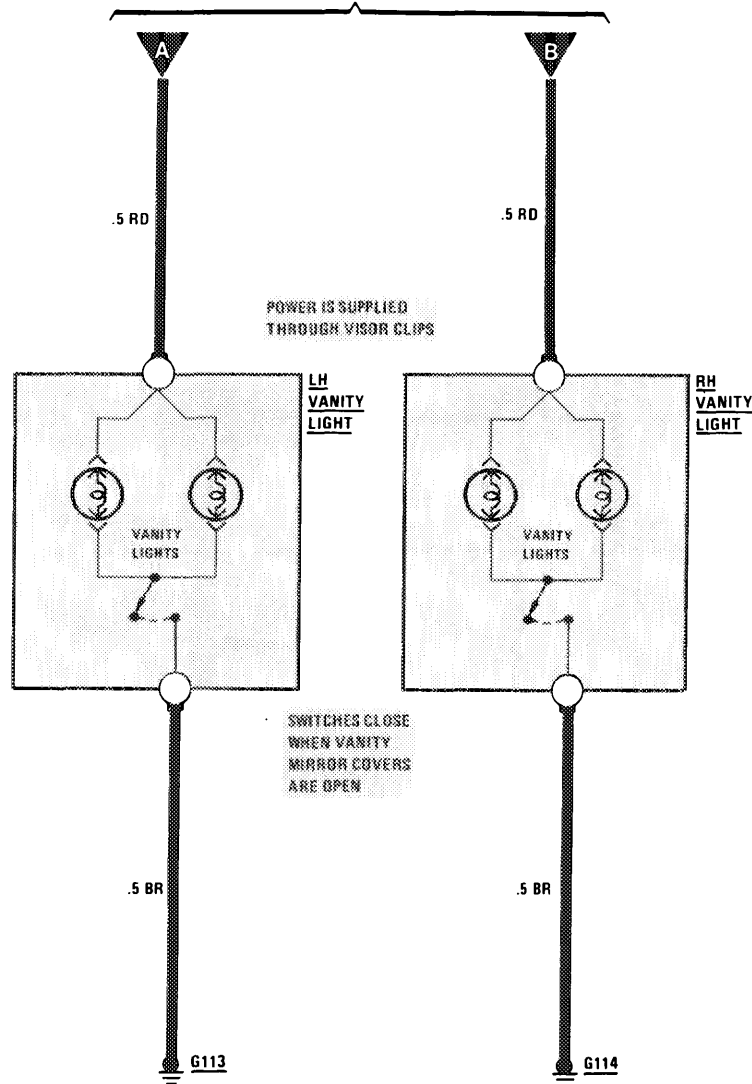

107.045

REVISIONS:

# COURTESY LIGHTS

(For Component Locations See Page 204)

MY 1985  
380 SL

107.045

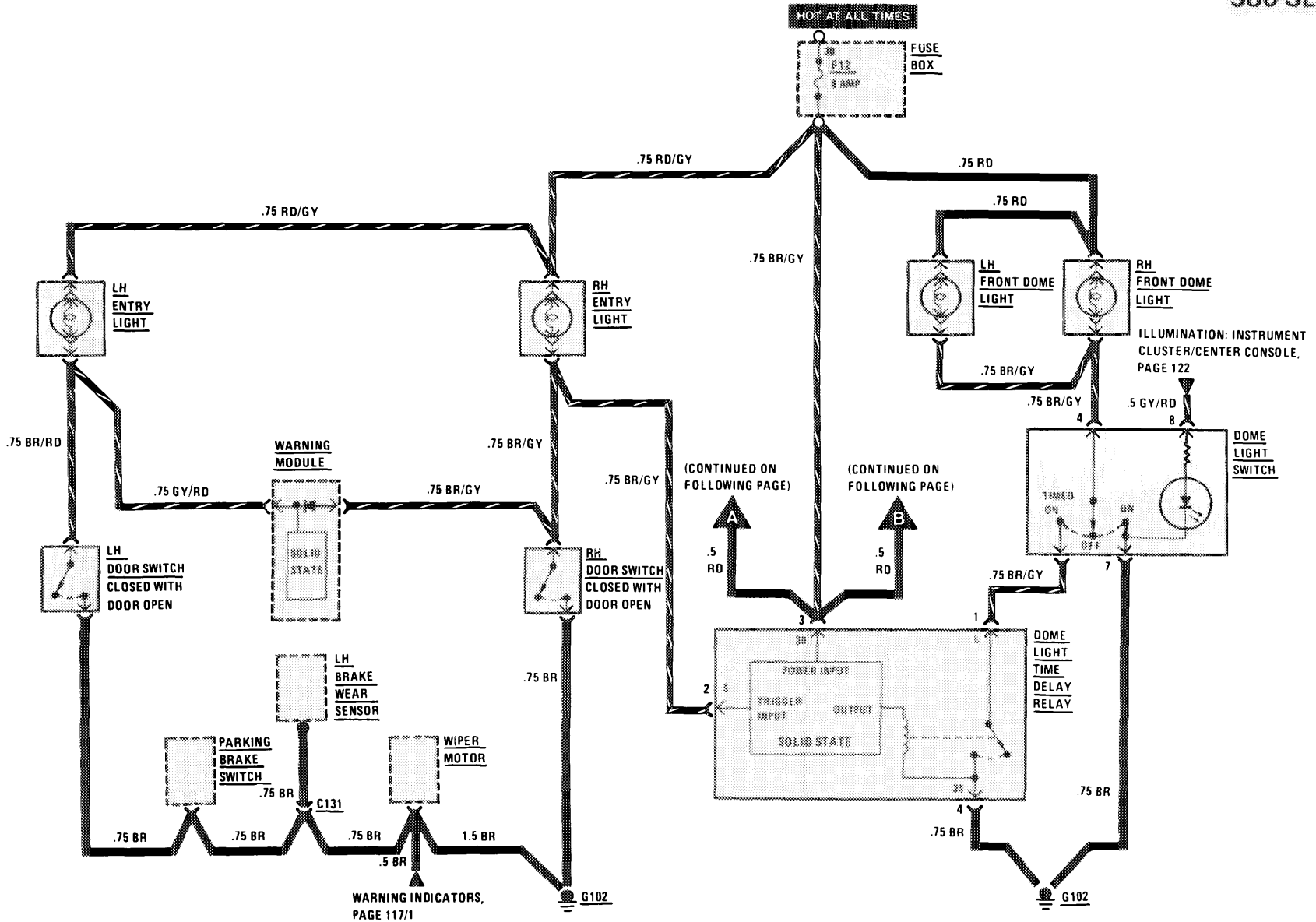

121/2

REVISIONS:

--	--	--

# VANITY LIGHTS

(For Component Locations See Page 204)

(CONTINUED FROM PRECEDING PAGE)

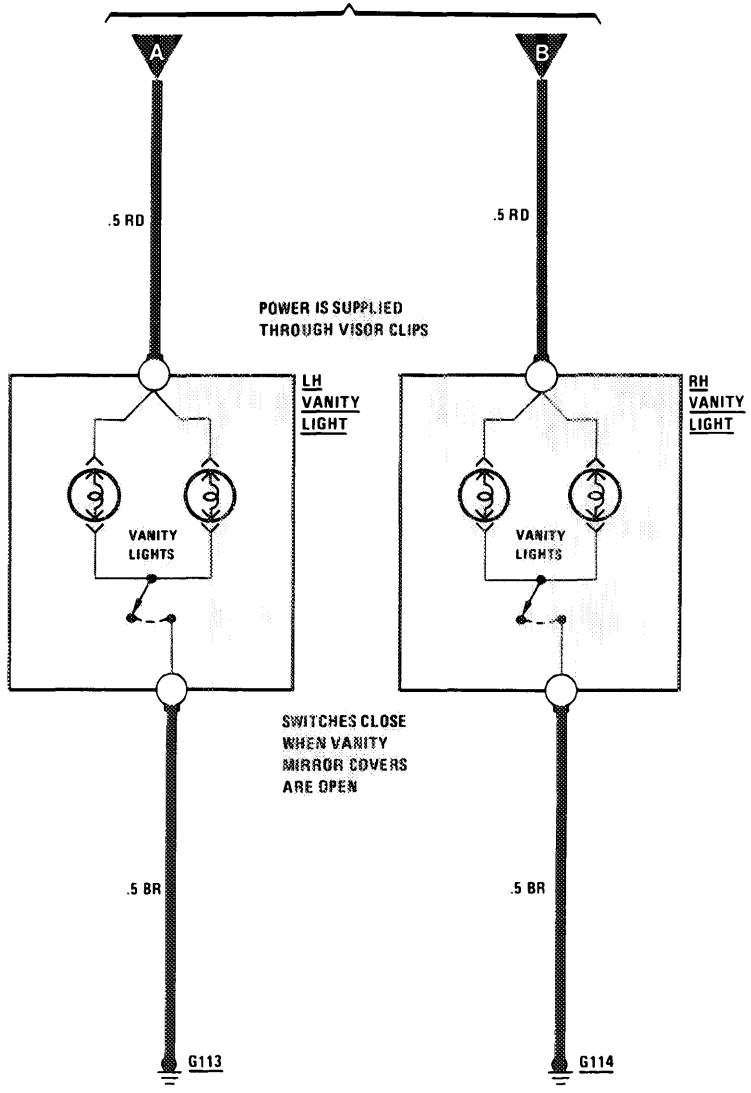

107.045

REVISIONS:
------------



THIS PAGE LEFT BLANK INTENTIONALLY

REVISIONS:

--

# ILLUMINATION: INSTRUMENT CLUSTER/CENTER CONSOLE MY 1983/MY 1984/

(For Component Locations See Page 208)

MY 1985  
380 SL

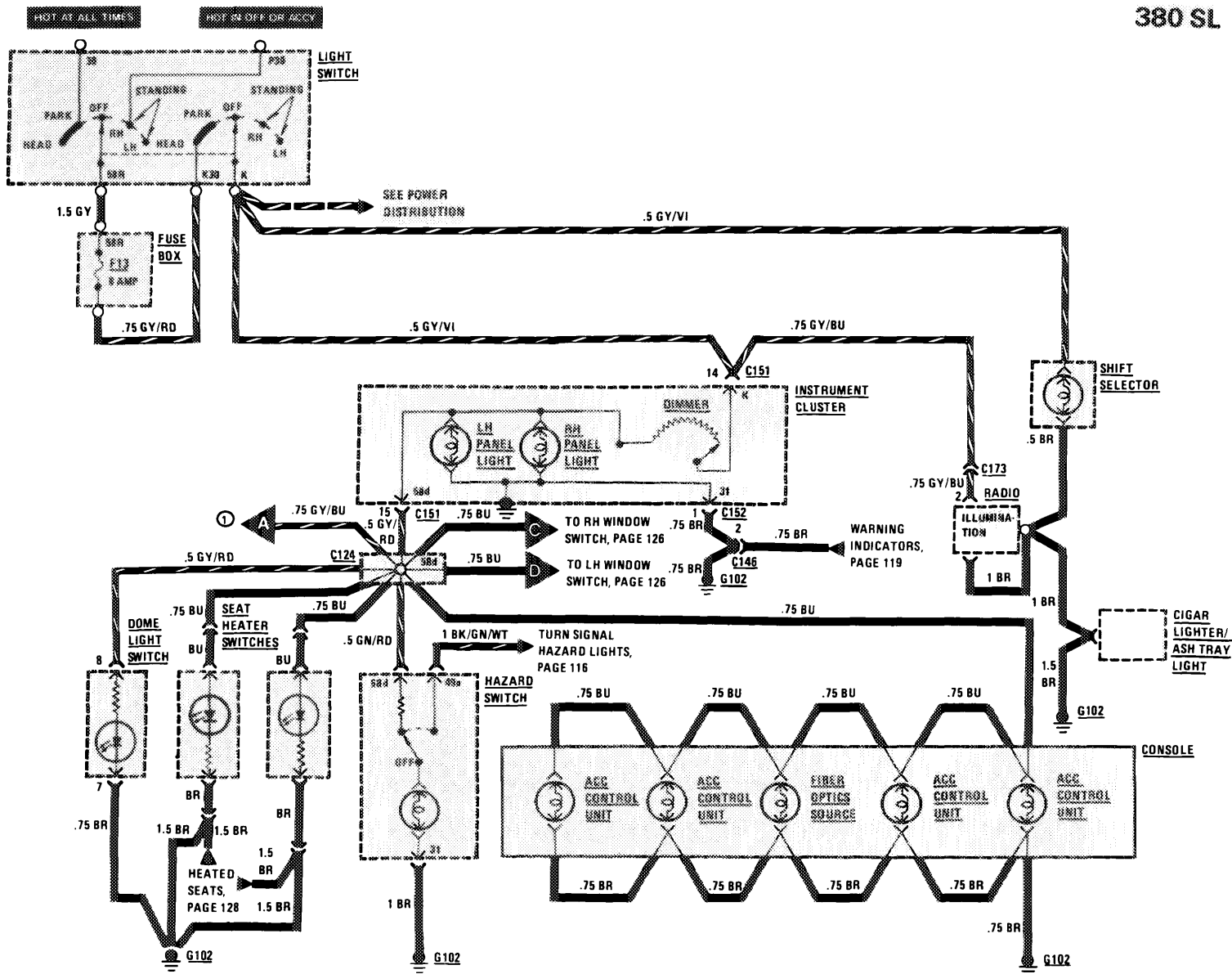

REVISIONS: ① MODEL YEARS 1984 AND 1985, PAGE 120

122

107.045

1/87

### HORNS

(For Component Locations See Page 206)

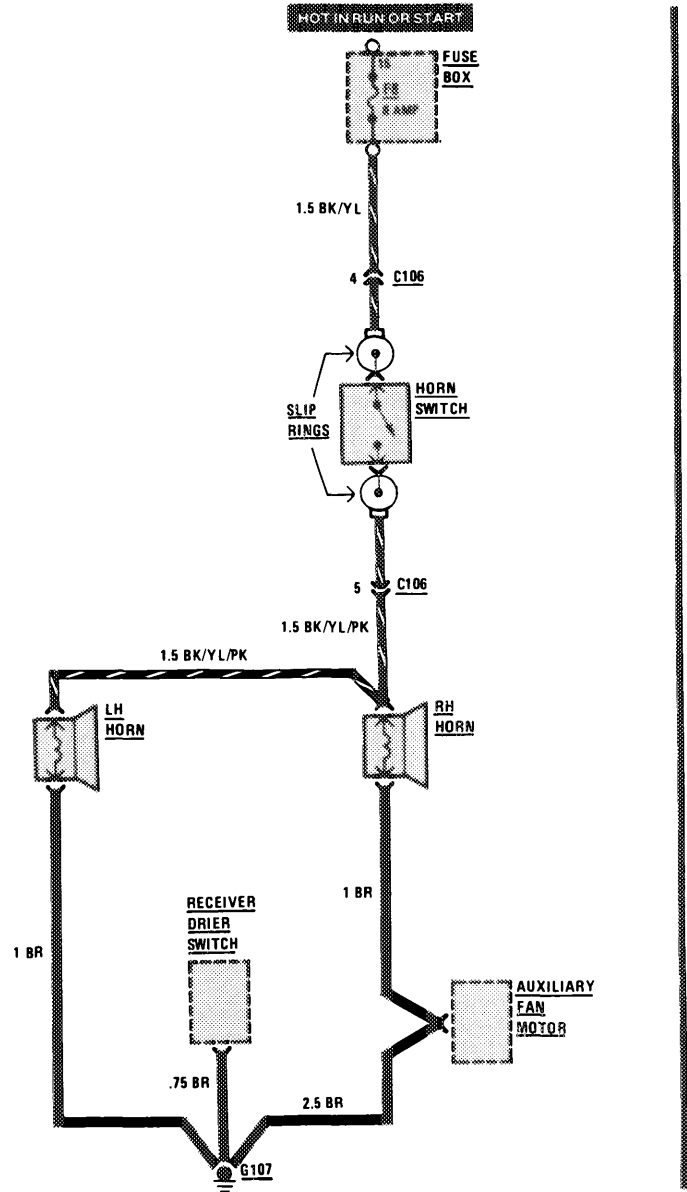

### AUXILIARY FAN MY 1983/MY 1984

380 SL

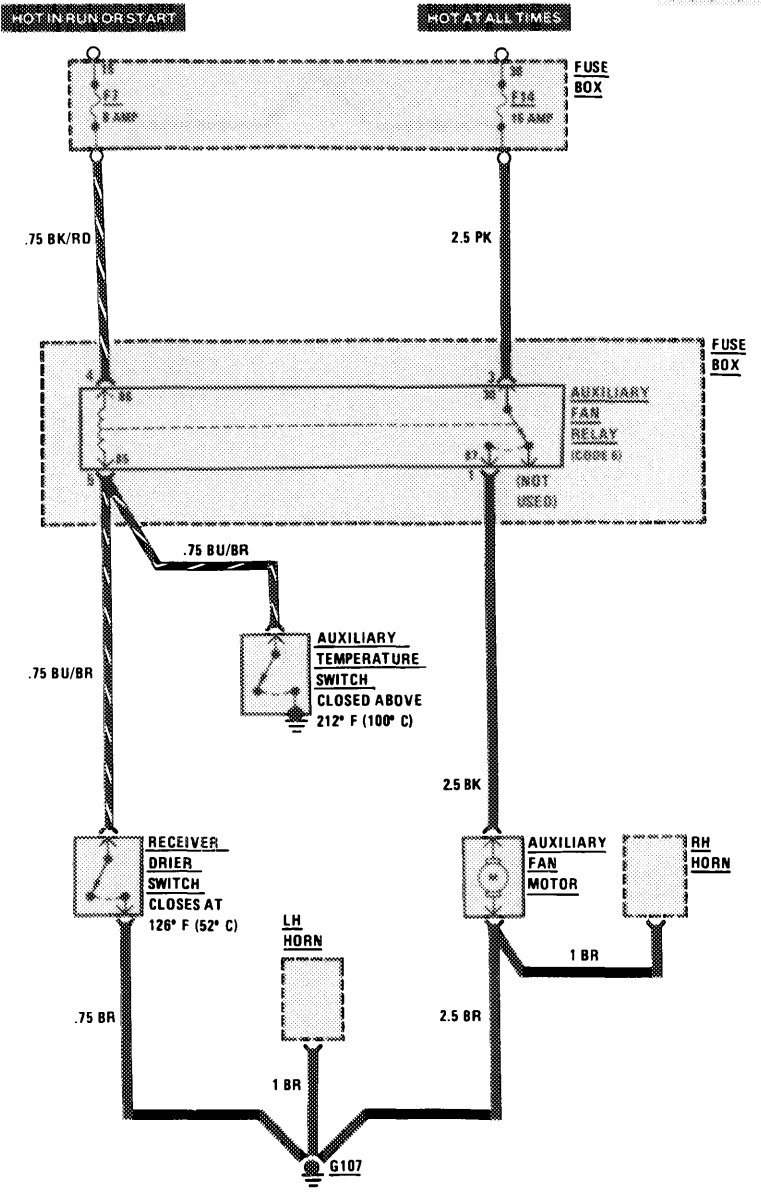

REVISIONS:

123/1

107.045

# HORNS

(For Component Locations See Page 206)

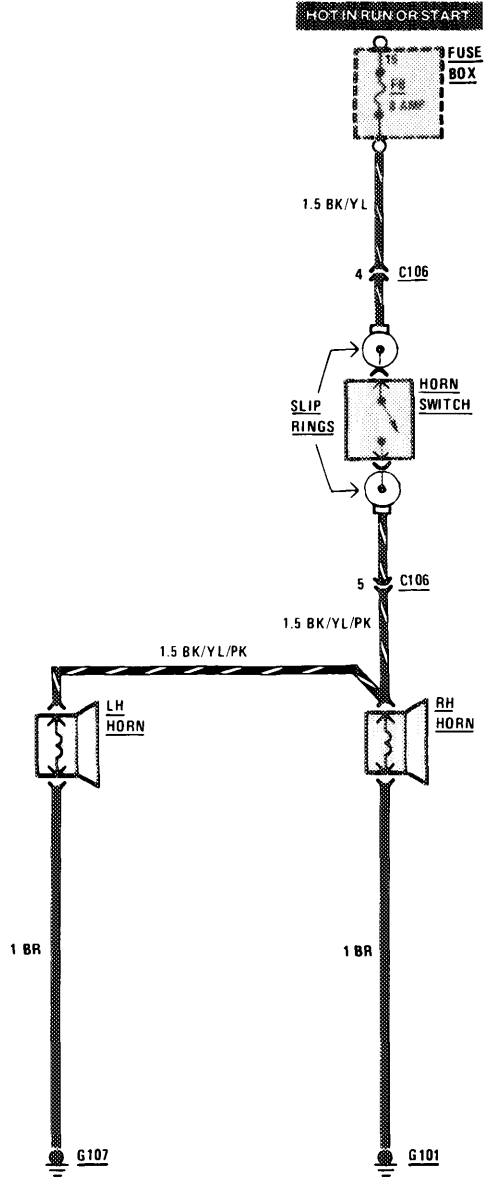

# AUXILIARY FAN

MY 1985

380 SL

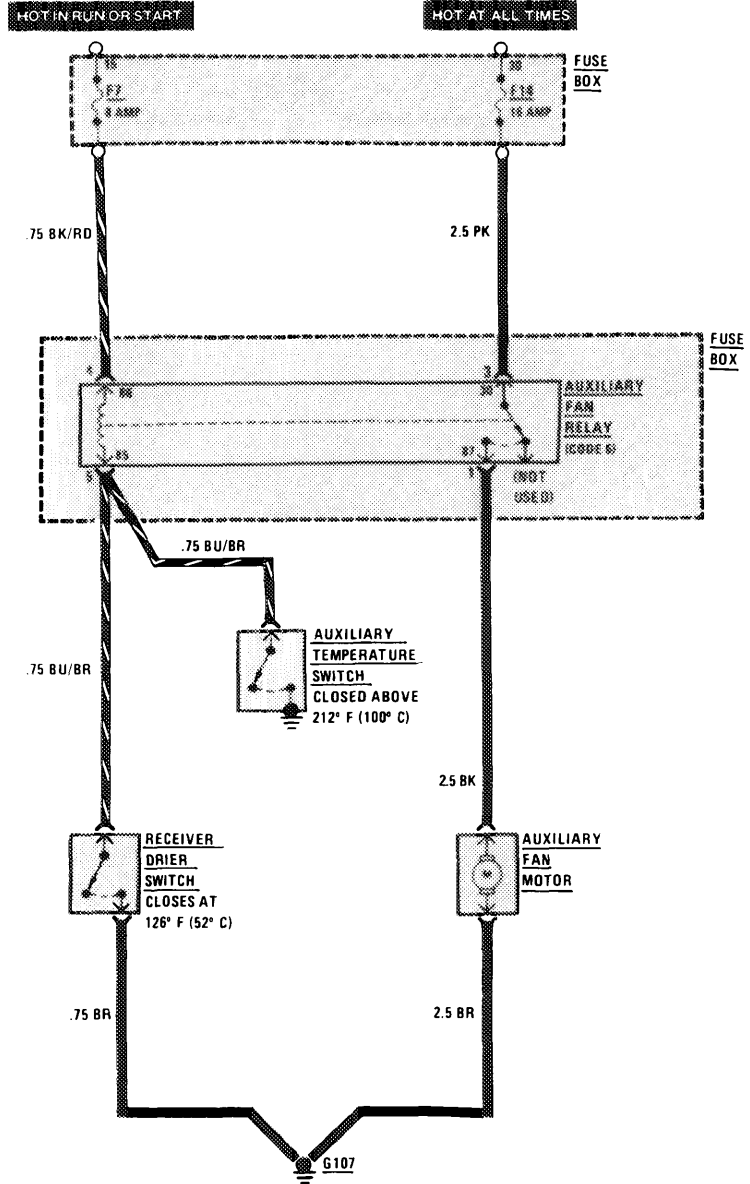

REVISIONS:

4/86

THIS PAGE LEFT BLANK INTENTIONALLY

REVISIONS:

# WIPER/WASHER

(For Component Locations See Page 213)

MY 1983/MY 1984/MY 1985

380 SL

124

107.045

HOT IN ASSY RUN OR START

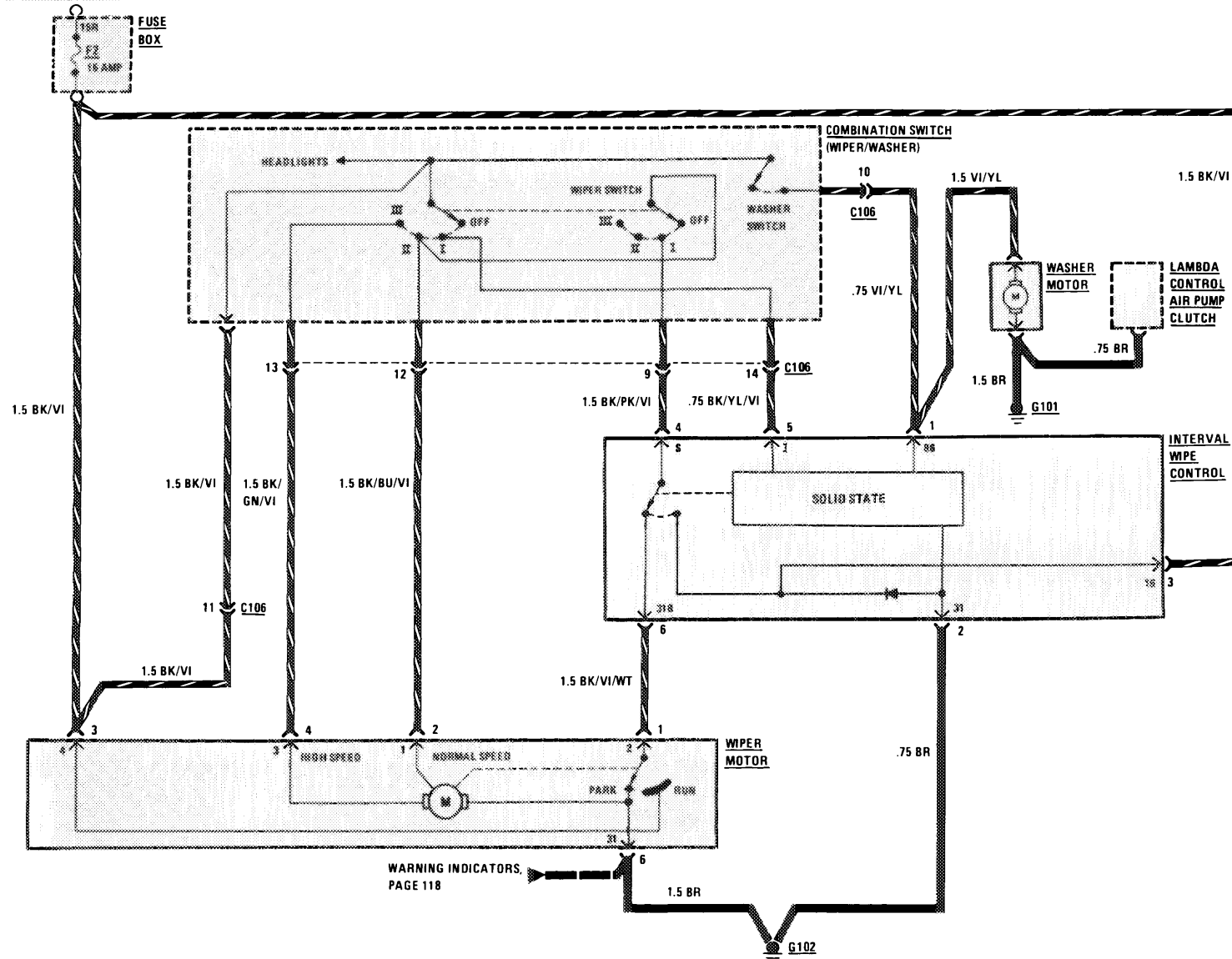

REVISIONS:

1/87

# REAR DEFOGGER

(For Component Locations See Page 210)

MY 1983 - MY 1985

380SL

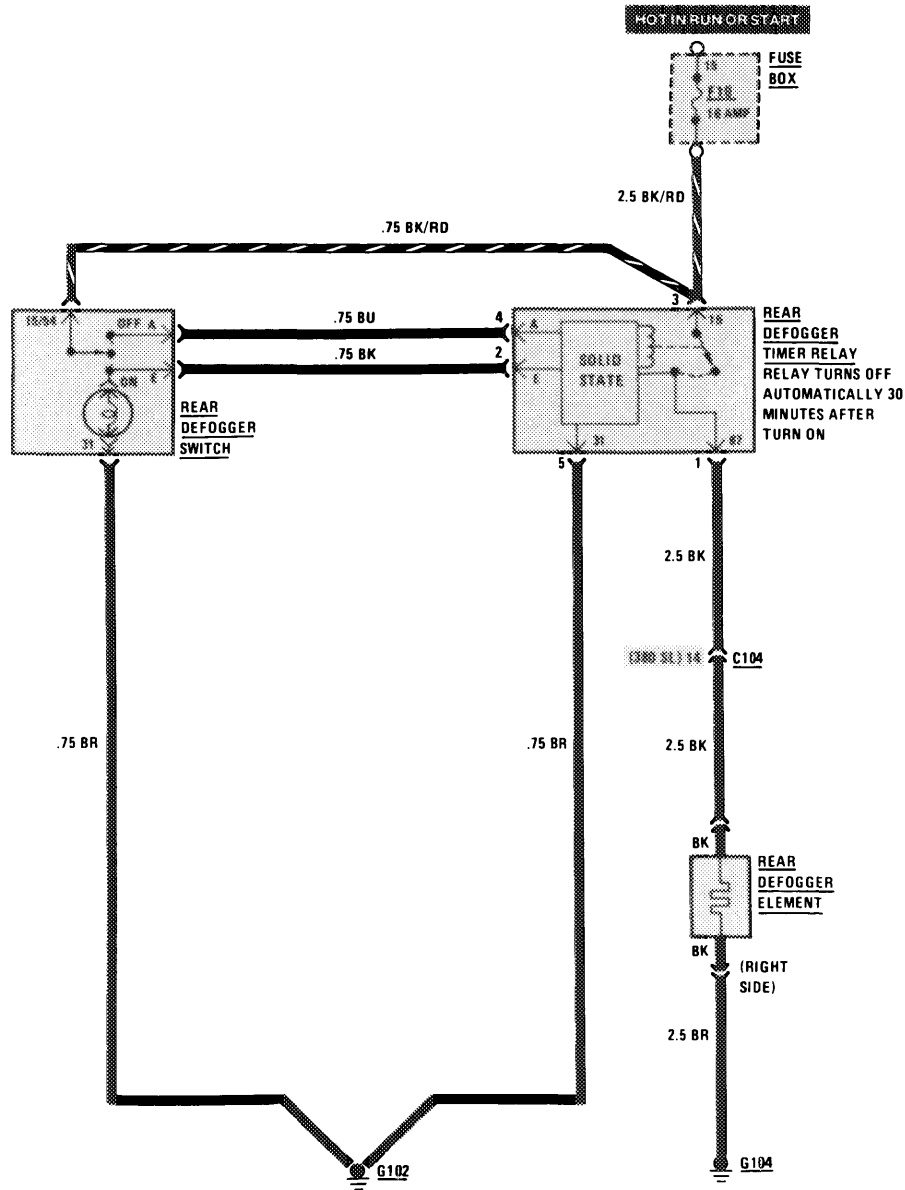

107.045

REVISIONS:

# POWER WINDOWS

(For Component Locations See Page 210)

MY 1983 - MY 1985

380SL

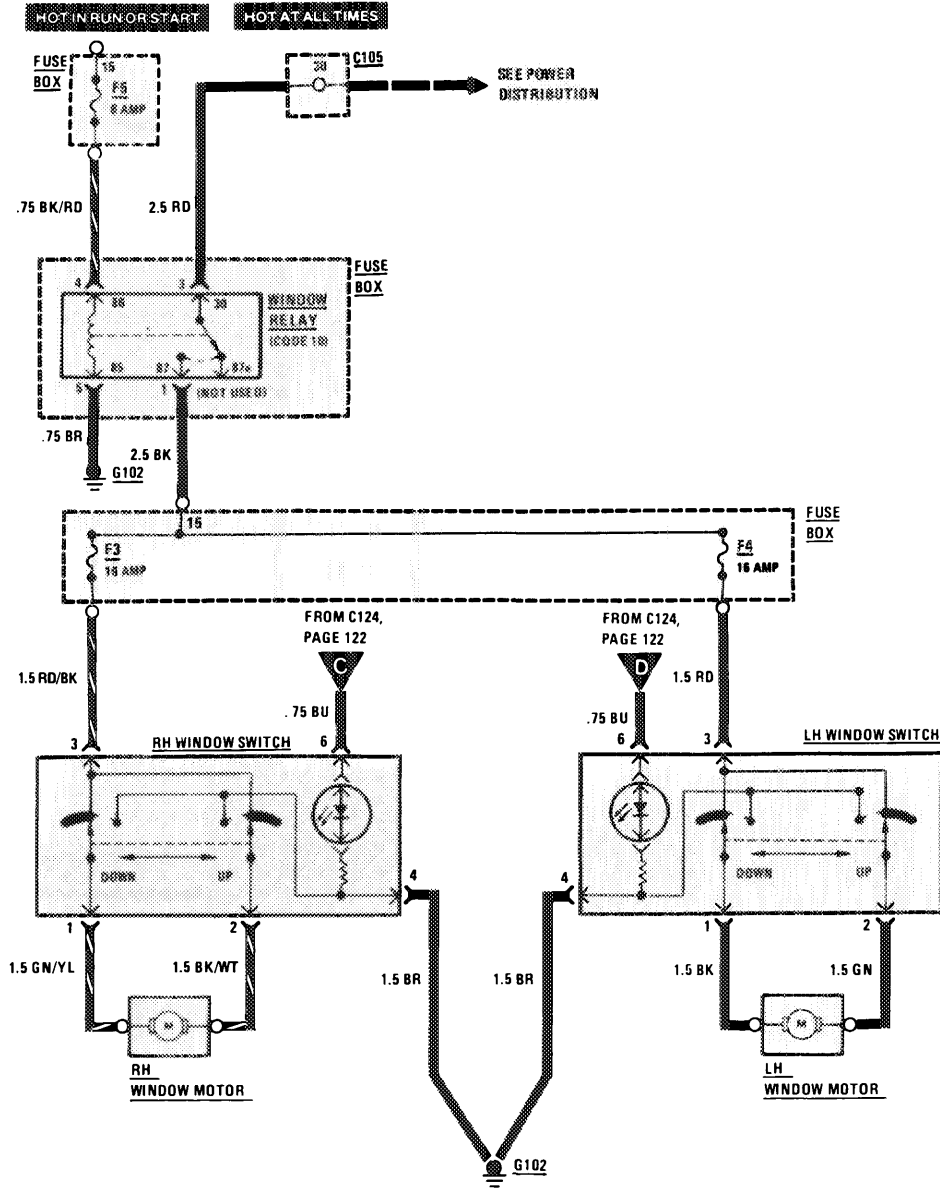

REVISIONS:



# CIGAR LIGHTER/RADIO/AUTOMATIC ANTENNA

(For Component Locations See Page 204)

MY 1983

380 SL

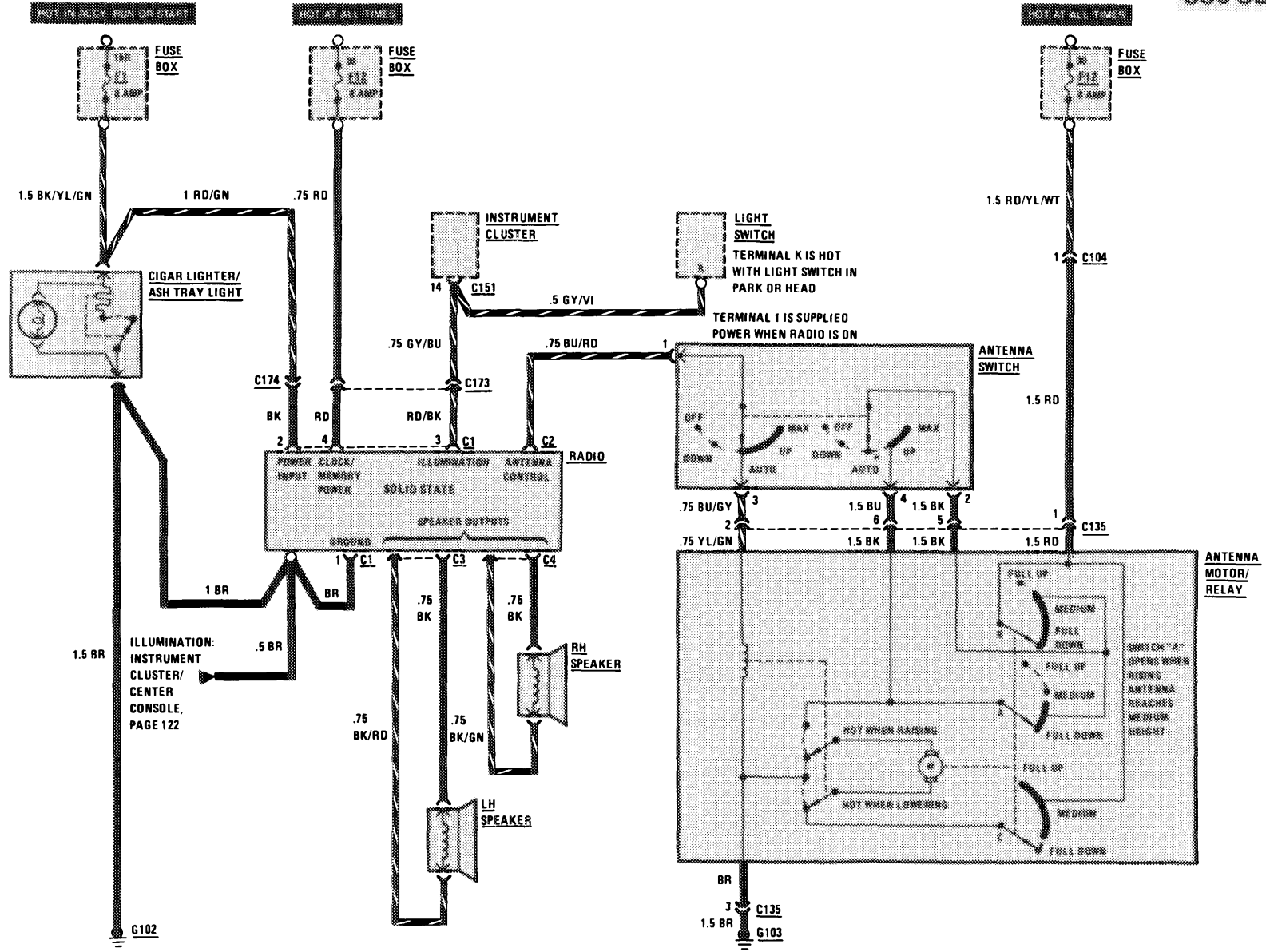

REVISIONS:

--	--	--

1/87

107.045

127

# CIGAR LIGHTER/RADIO/AUTOMATIC ANTENNA

(For Component Locations See Page 204)

MY 1984

380 SL

127/1

107.045

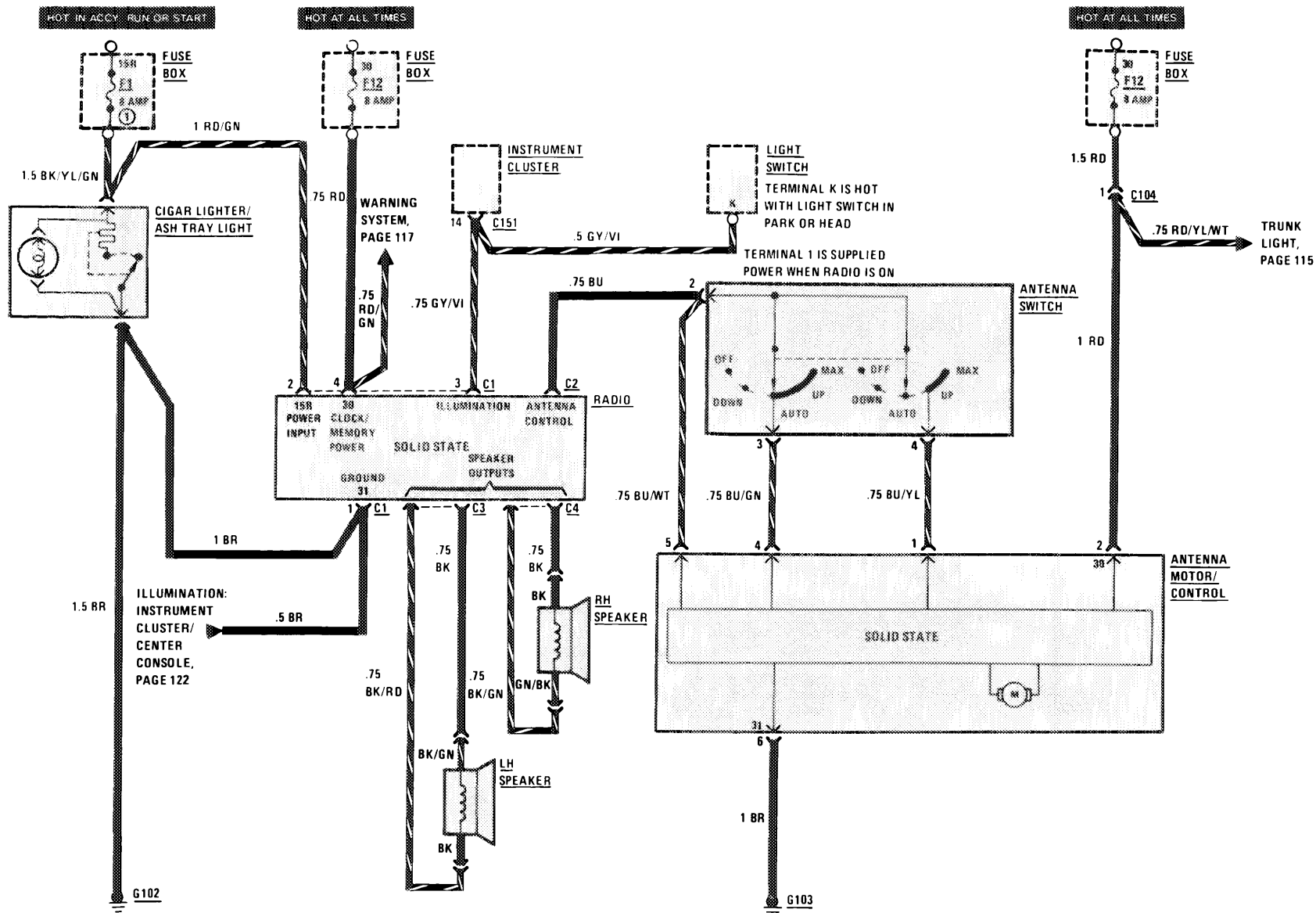

REVISIONS: ① 16 AMP (WHEN EQUIPPED WITH HEATED SEATS)

4/86

# CIGAR LIGHTER/RADIO/AUTOMATIC ANTENNA

(For Component Locations See Page 204)

MY 1985

380 SL

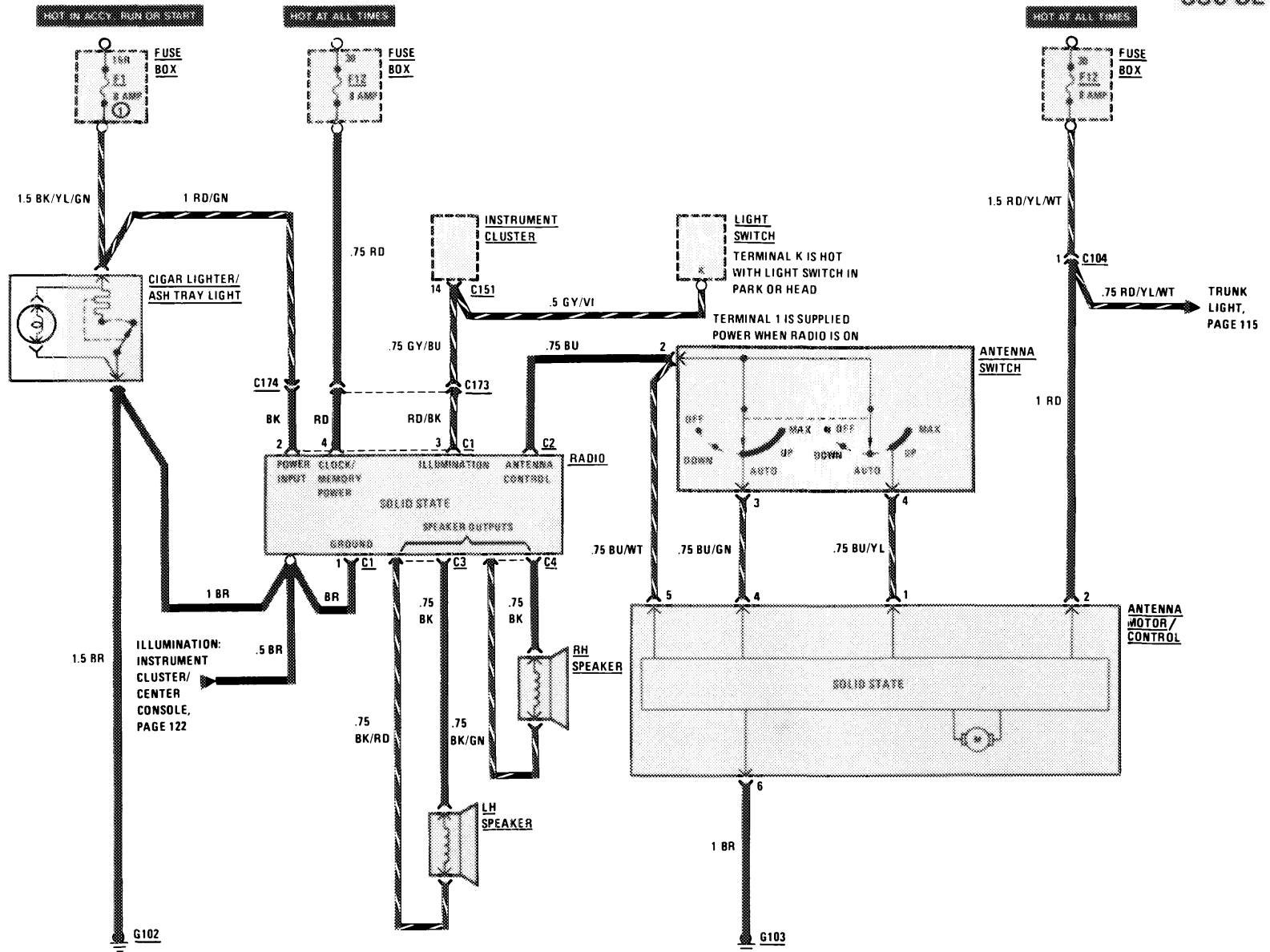

REVISIONS: ① 16 AMP (WHEN EQUIPPED WITH HEATED SEATS)

1/87

107.045

127/2

THIS PAGE LEFT BLANK INTENTIONALLY

REVISIONS:

THIS PAGE LEFT BLANK INTENTIONALLY

127/4

REVISIONS:

--

# HEATED SEATS

(For Component Locations See Page 206)

MY 1983  
380 SL

HST IN ACCY RUN ON START

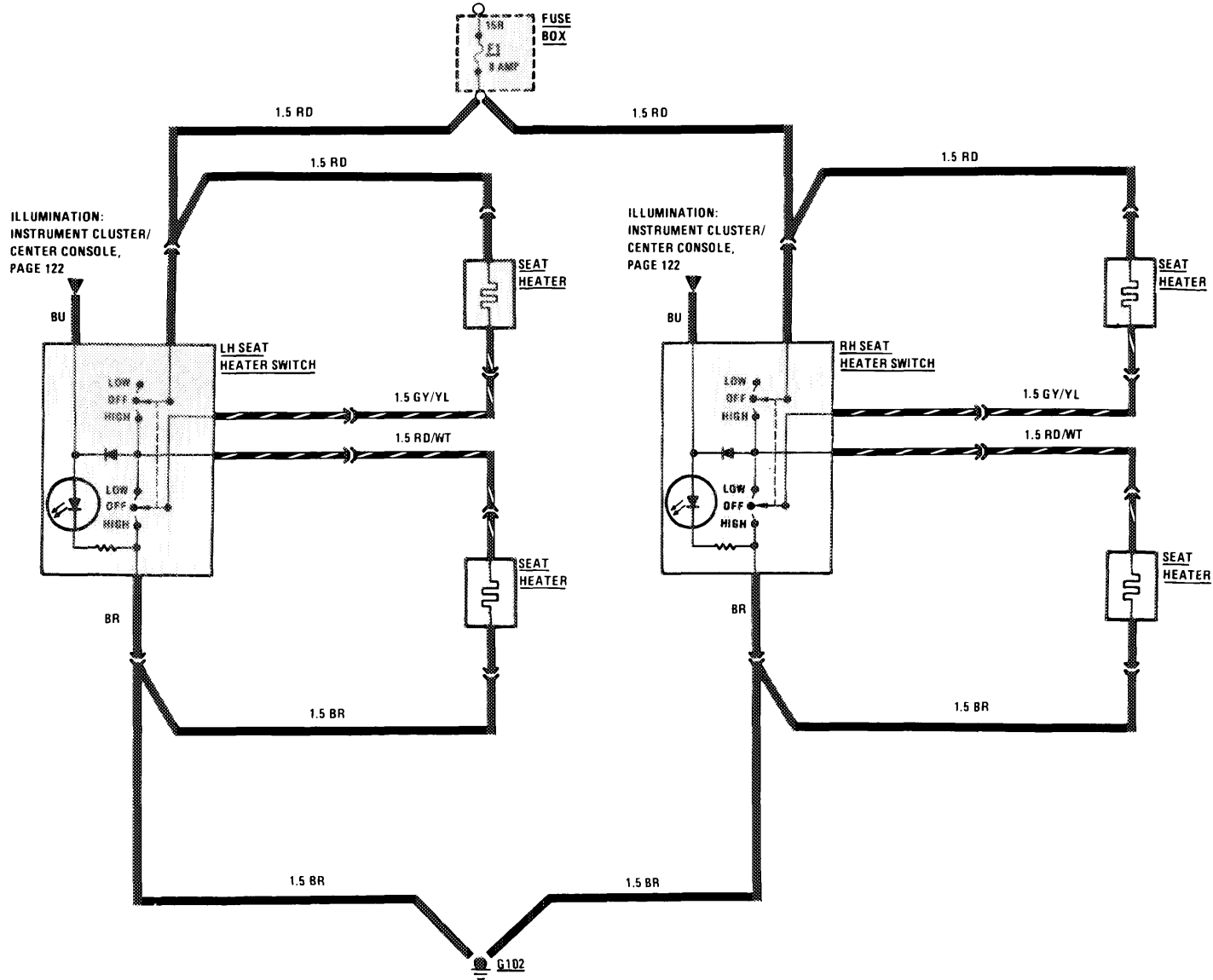

REVISIONS:

128

107.045

4/86

# HEATED SEATS

(For Component Locations See Page 206)

MY 1984 - MY 1985

380SL

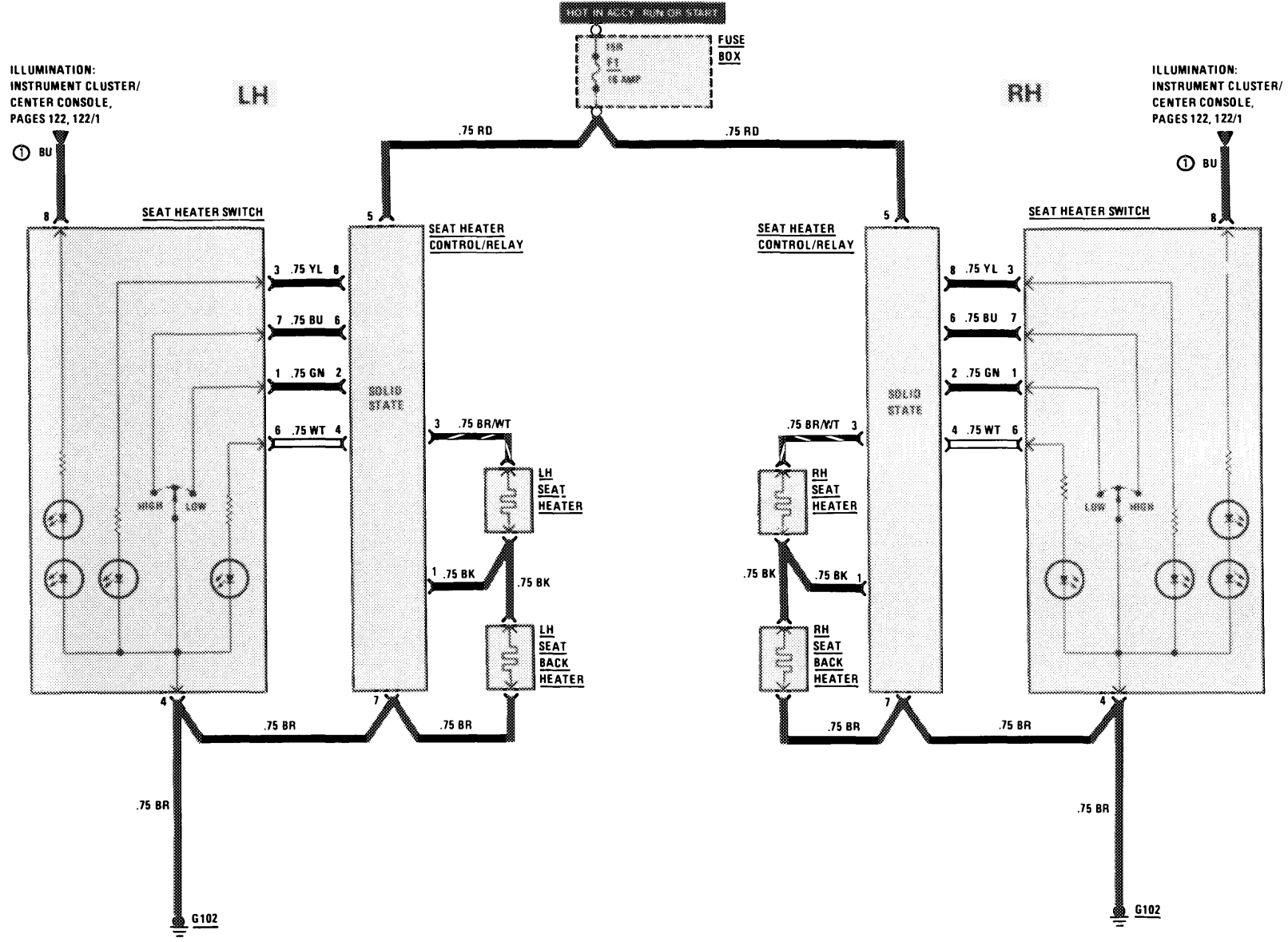

ILLUMINATION:  
INSTRUMENT CLUSTER/  
CENTER CONSOLE,  
PAGES 122, 122/1

ILLUMINATION:  
INSTRUMENT CLUSTER/  
CENTER CONSOLE,  
PAGES 122, 122/1

107.045

REVISIONS: ① MODEL YEARS 1984 AND 1985

THIS PAGE LEFT BLANK INTENTIONALLY

REVISIONS:



# RH OUTSIDE MIRROR

(For Component Locations See Page 210)

MY 1983/MY 1984/MY 1985  
380 SL

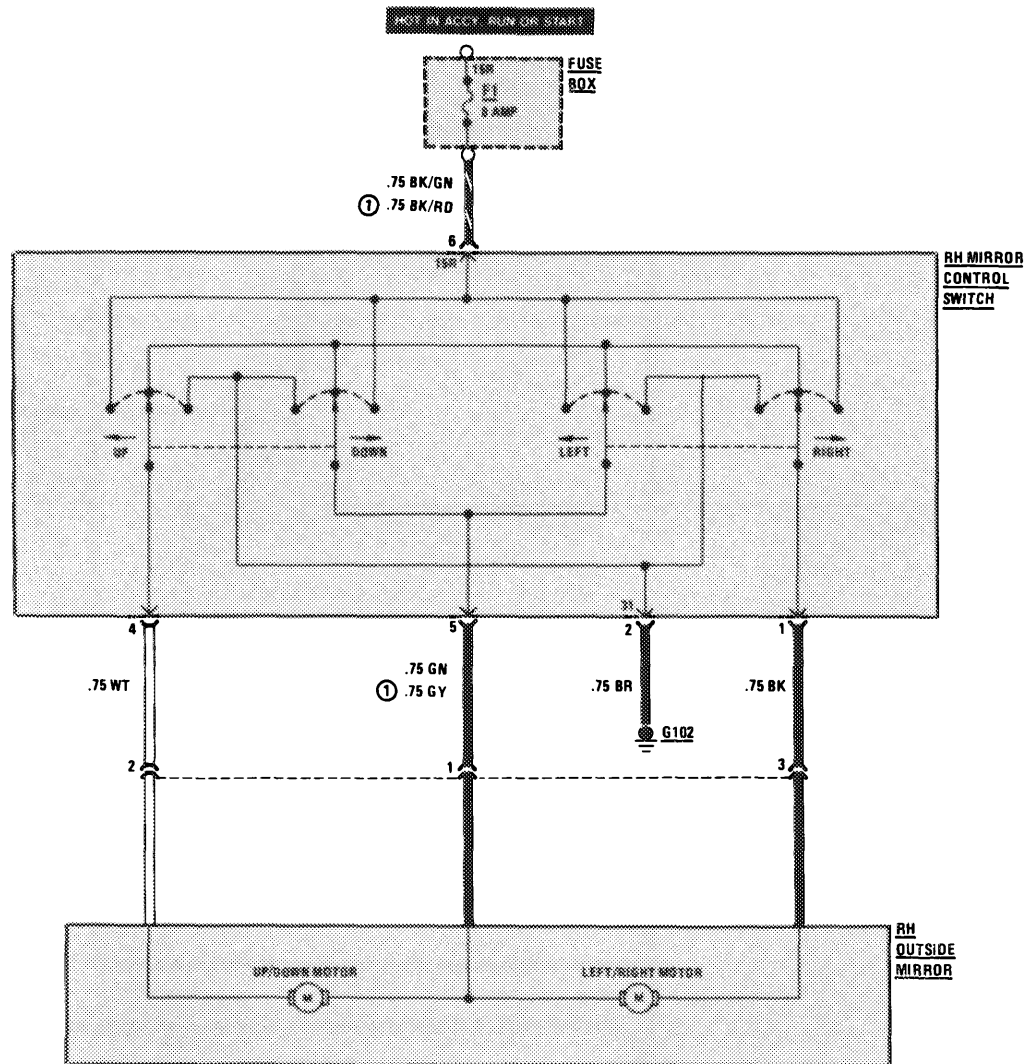

REVISIONS: ① AS OF MODEL YEAR 1985

# OUTSIDE HEATED MIRRORS

(For Component Locations See Page 209)

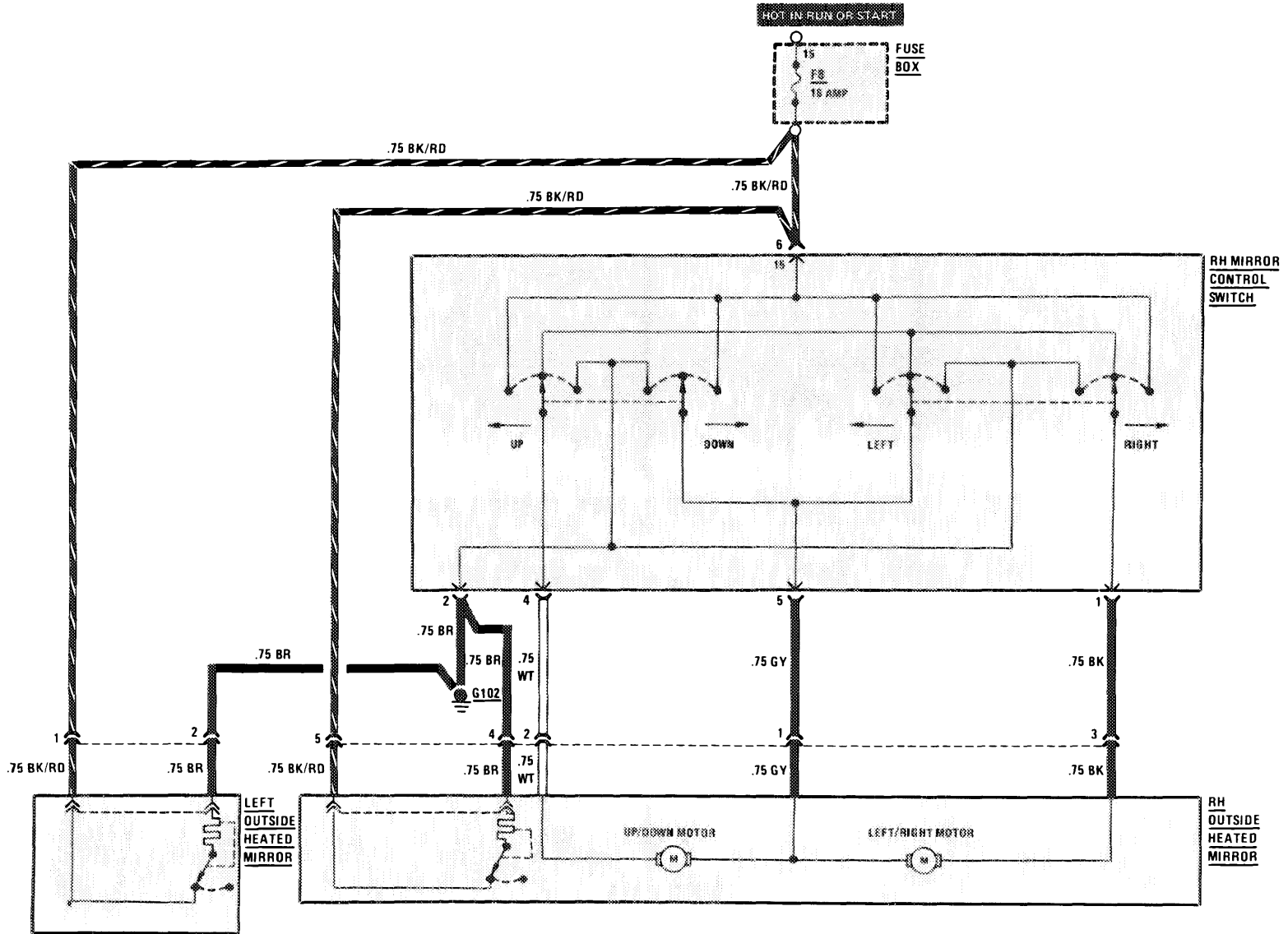

107.045

REVISIONS:

# SUPPLEMENTAL RESTRAINT SYSTEM (SRS) (WITH AIR BAG)

(For Component Locations See Page 211)

MY 1985

380SL

**WARNING:**  
 GAS GENERATORS ARE TI PYROTECHNIC DEVICES, WHICH CAN CAUSE SEVERE INJURY IF ACCIDENTALLY DETONATED. BEFORE TESTING, REPAIRING OR HANDLING ANY PART OF THIS SYSTEM, DISCONNECT THE VEHICLE BATTERY AND SEPARATE THE RED 10 PIN CONNECTOR (C178). THE CONNECTOR IS LOCATED ON THE PARKING BRAKE BRACKET. GROUP 91 OF THE SERVICE MICROPHONE SYSTEM CONTAINS PROCEDURES FOR TESTING, REMOVING, REPLACING, AND DISPOSING OF SYSTEM COMPONENTS. OBSERVE ALL CAUTIONS FOUND IN THIS INFORMATION.

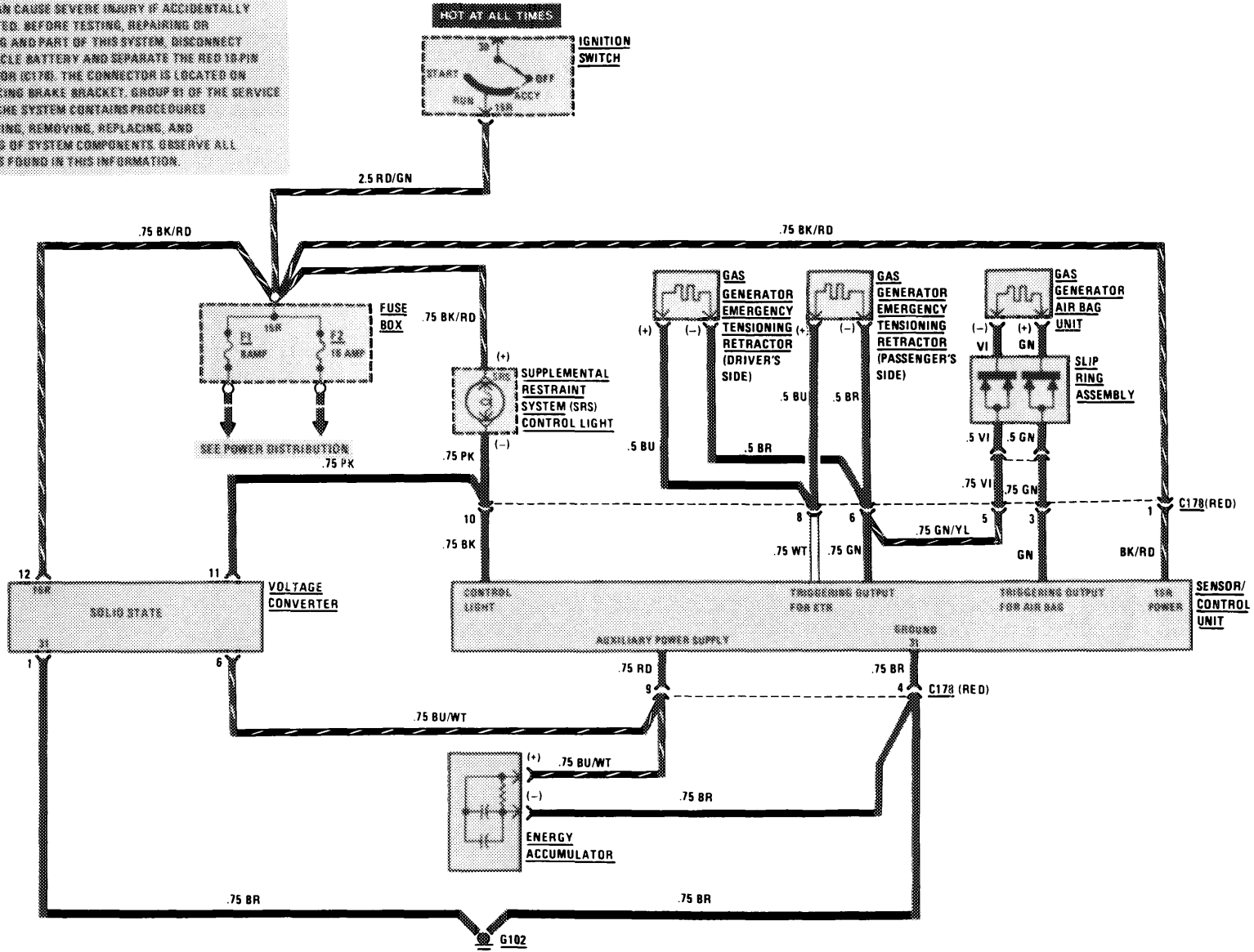

107.045

REVISIONS:

# ANTILOCK BRAKE SYSTEM

(For Component Locations See Page 201)

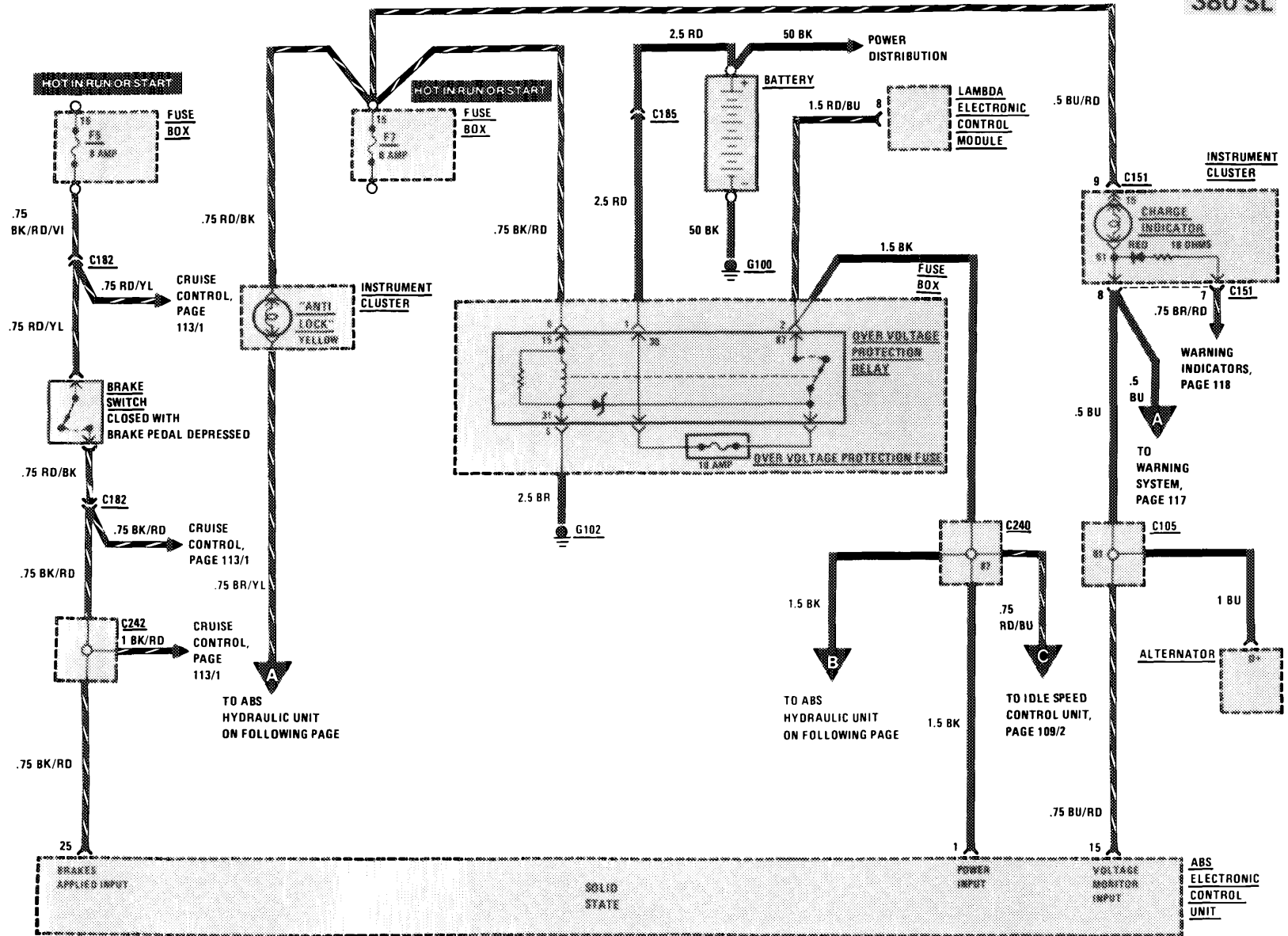

REVISIONS:

# ANTILOCK BRAKE SYSTEM

(For Component Locations See Page 201)

MY 1985

380 SL

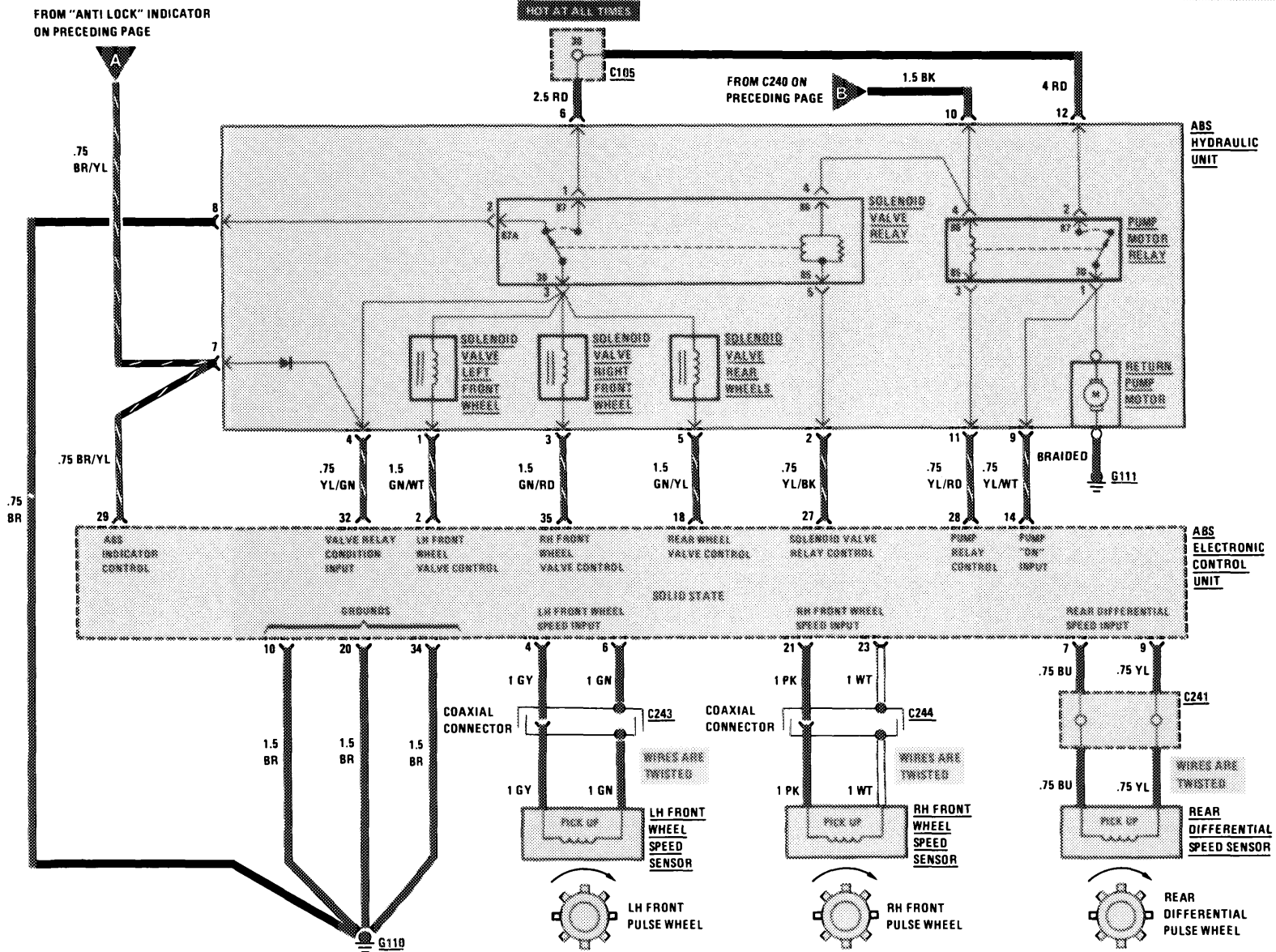

REVISIONS:

THIS PAGE LEFT BLANK INTENTIONALLY

REVISIONS:

THIS PAGE LEFT BLANK INTENTIONALLY

REVISIONS:

--

THIS PAGE LEFT BLANK INTENTIONALLY

REVISIONS:



THIS PAGE LEFT BLANK INTENTIONALLY

REVISIONS:

--

THIS PAGE LEFT BLANK INTENTIONALLY

REVISIONS:

THIS PAGE LEFT BLANK INTENTIONALLY

REVISIONS:

GROUND DISTRIBUTION

MY 1983/MY 1984/MY 1985

380 SL

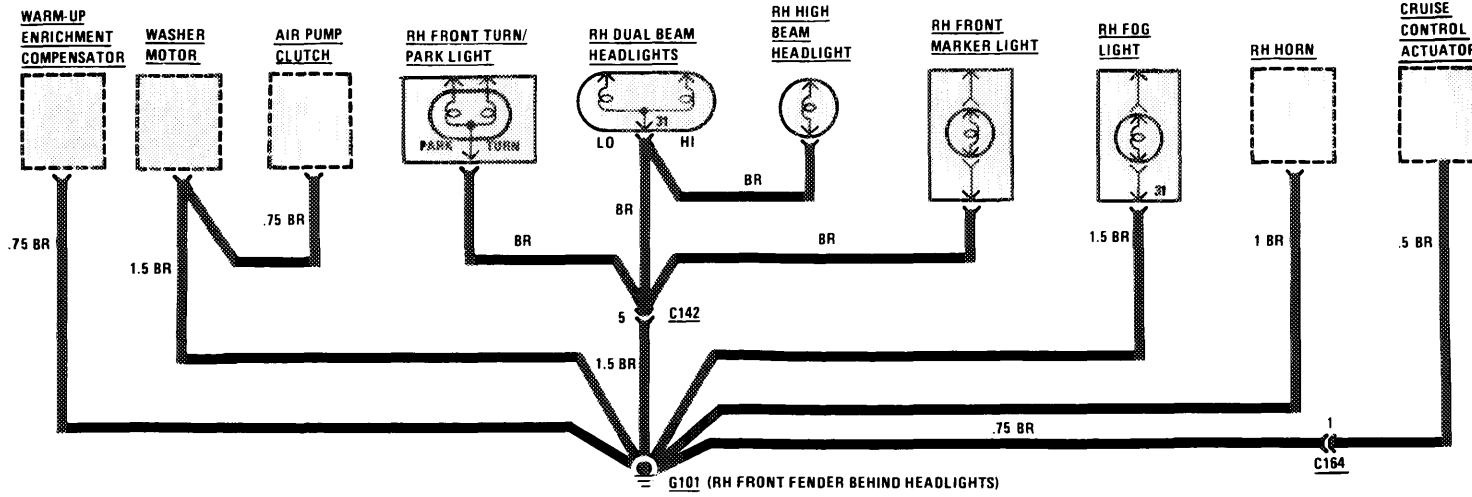

138

AS OF MY 1984

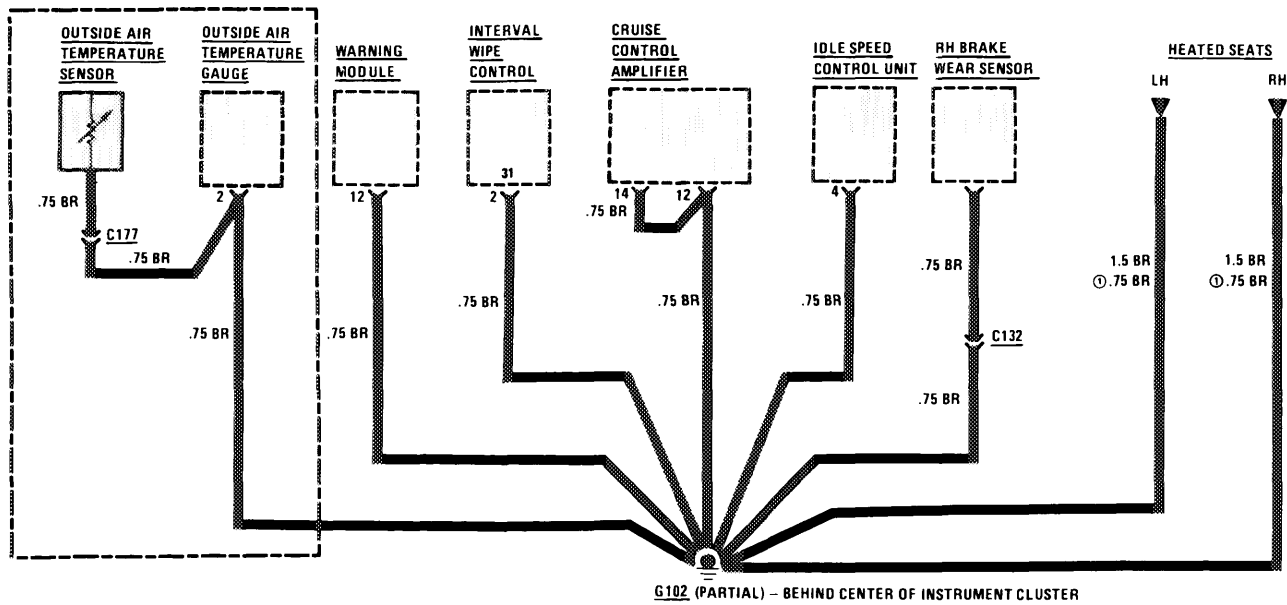

107.045

REVISIONS: Ⓞ AS OF MODEL YEAR 1984

1/87

# GROUND DISTRIBUTION

MY 1983/MY 1984/MY 1985

380 SL

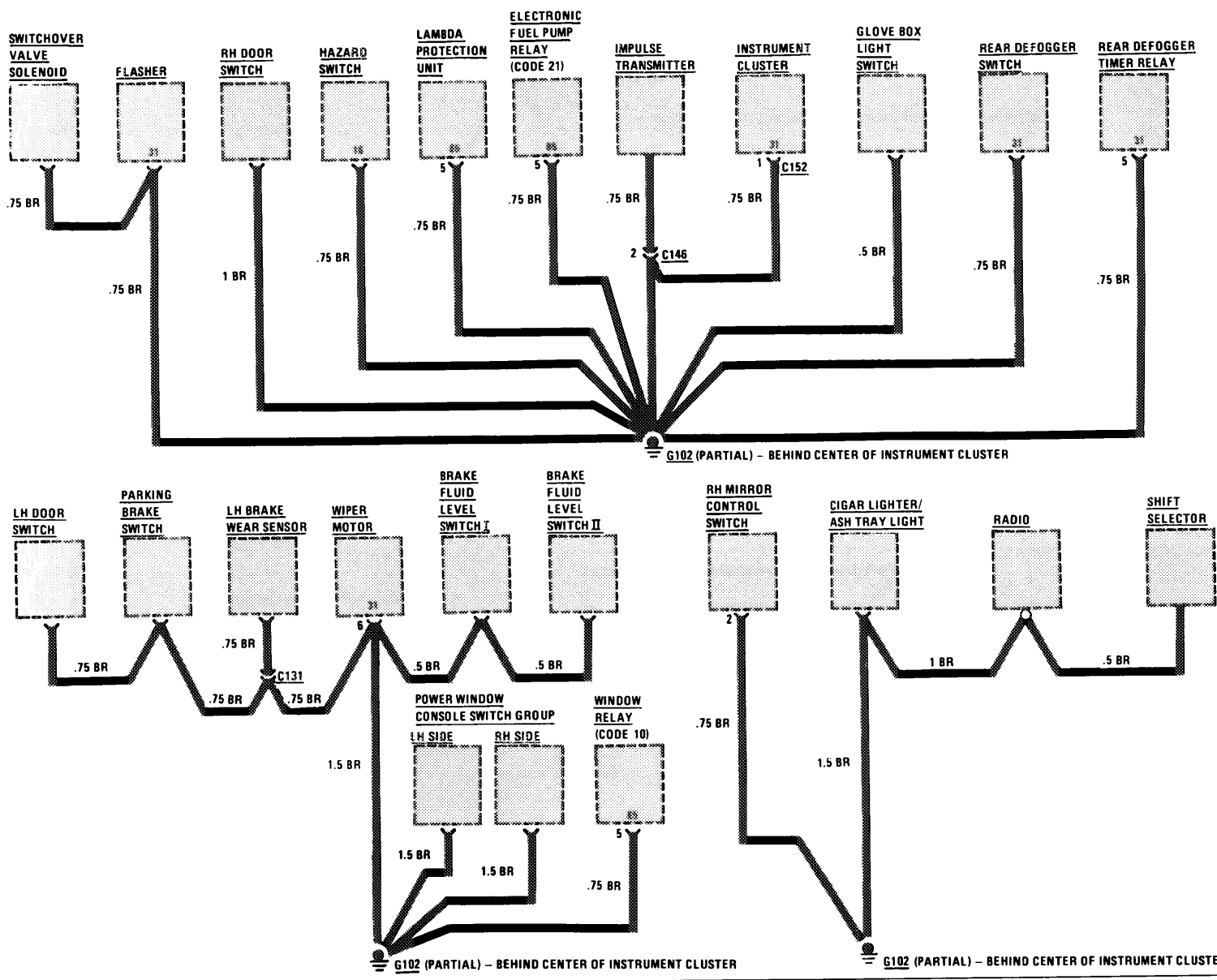

REVISIONS:

4/86

107.045

139

# GROUND DISTRIBUTION

MY 1983/MY 1984/MY 1985

380 SL

140

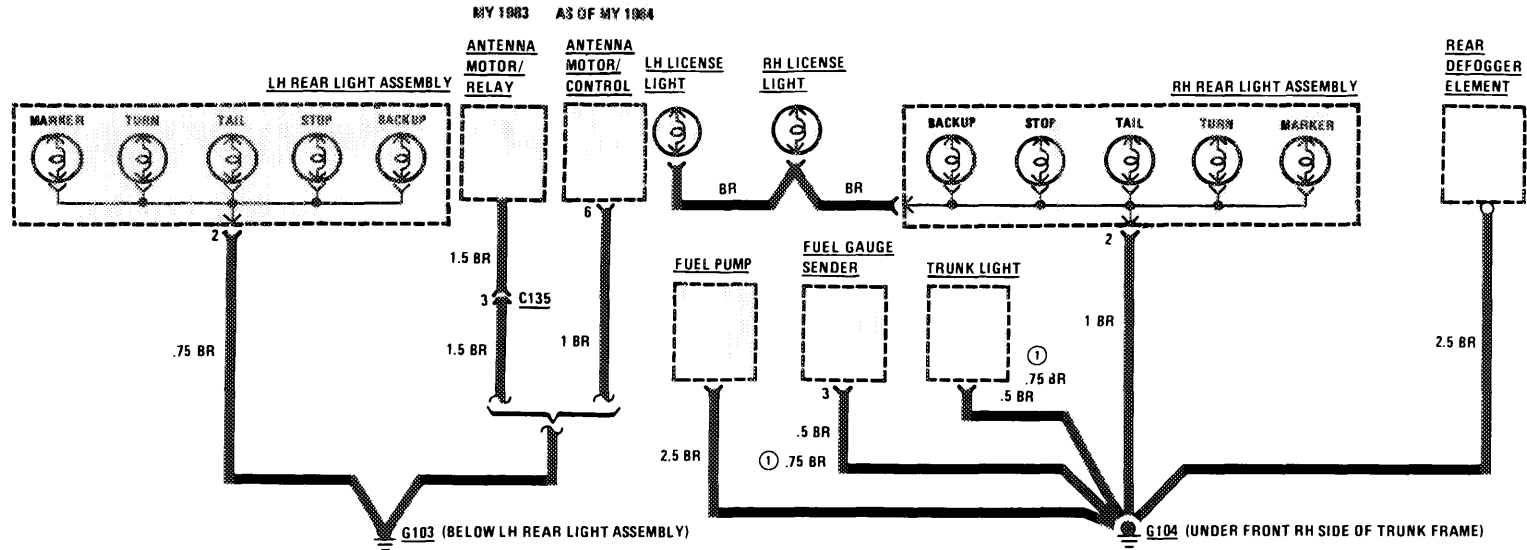

107.045

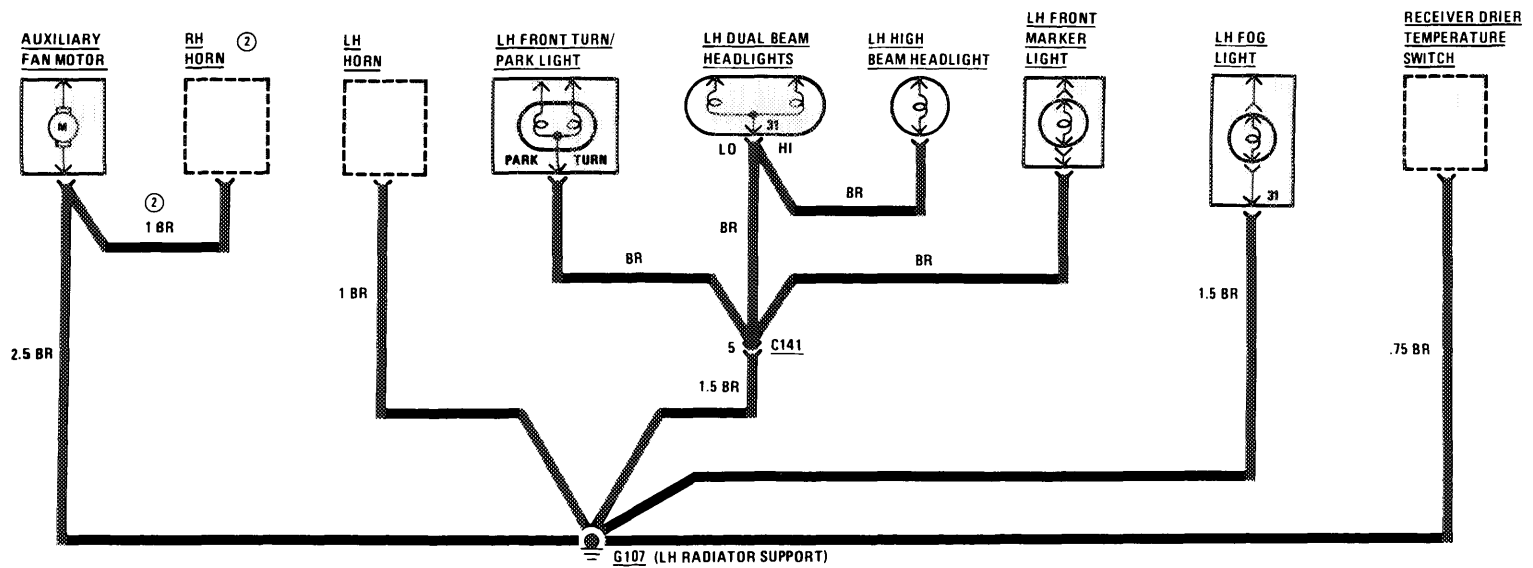

- REVISIONS:**
- ① AS OF MODEL YEAR 1984
  - ② AS OF MODEL YEAR 1985

4/86

# AUTOMATIC CLIMATE CONTROL (ACC) POWER AND GROUND DISTRIBUTION

(For Component Locations See Page 323)

MY 1983/

MY 1984/MY 1985

380 SL

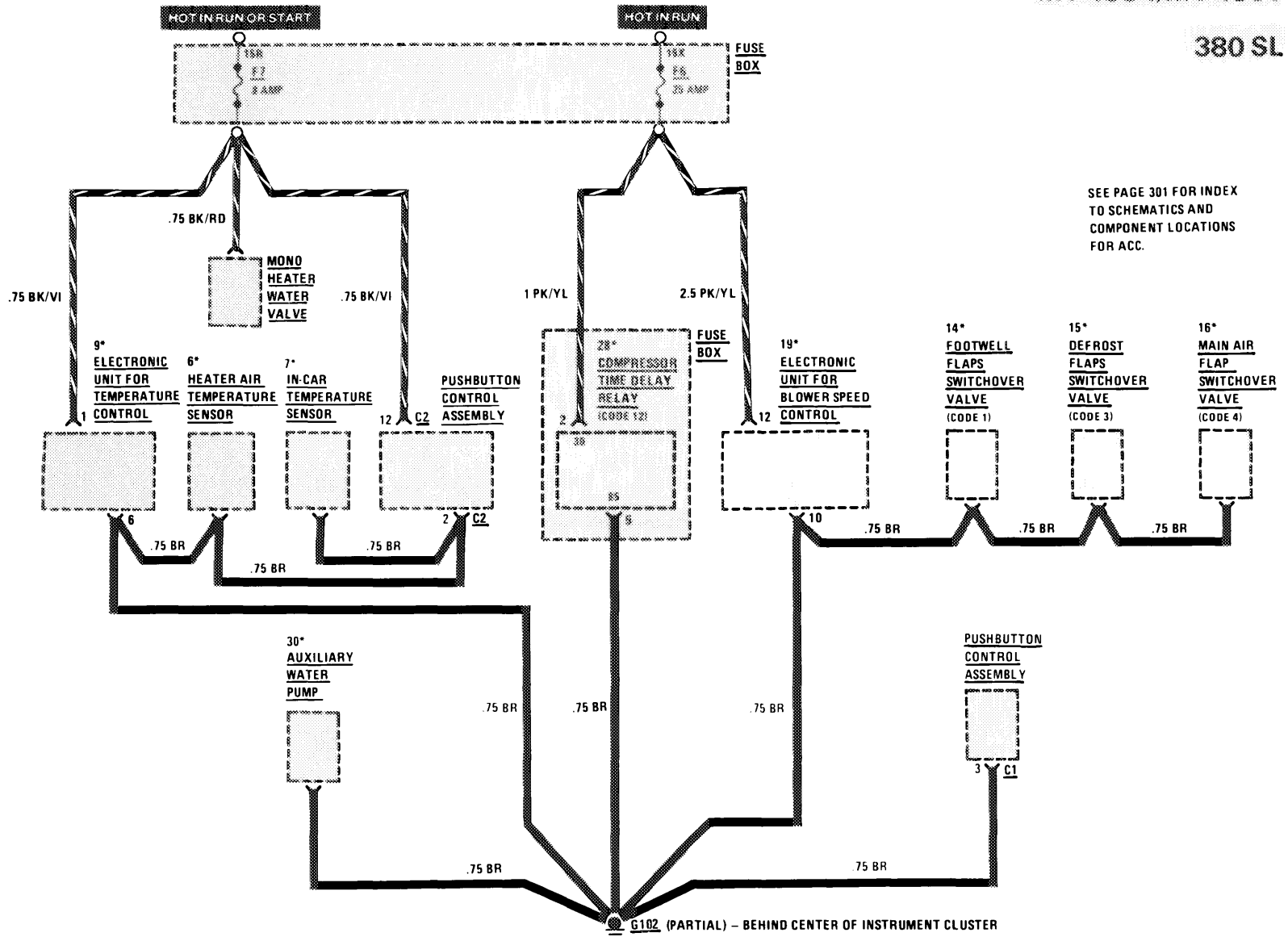

1/87

107.045

REVISIONS:

141

THIS PAGE LEFT BLANK INTENTIONALLY

REVISIONS: